





# SmartAXIS

FT2J

Instruction Manual

## SAFETY PRECAUTIONS

- Be certain to read this document carefully before performing installation, wiring, or maintenance and inspection works, or operating the SmartAXIS FT2J (Hereinafter referred to as "SmartAXIS"). If the SmartAXIS is used in a manner not specified by the manufacturer, the protection provided by the equipment may be impaired.
- The SmartAXIS has been manufactured with careful regard to quality. However, if you intend to use this product in applications where failure of this equipment may result in damage to property or injury, ensure that it used in conjunction with appropriate fail-safe backup equipment.
- Precautionary measure should be taken to avoid unauthorized access from the outside network to the SmartAXIS. Please note that the Company shall not be liable for any loss, damage or other expenses incurred directly or indirectly by unauthorized access, etc.
- In this document, safety precautions are categorized depending on the severity as Warning or Caution:

 <b>WARNING</b>	Warning notices are used to emphasize that improper operation may cause severe personal injury or death.
 <b>CAUTION</b>	Caution notices are used where inattention might cause personal injury or damage to equipment.

### WARNING

- This product is not designed for use in applications requiring a high degree of reliability and safety, such as applications for medical devices, nuclear power, railroads, aerospace, and automotive devices. This product should not be used for such applications.
- Turn off the power of this product before installation, removal, wiring, maintenance, and inspection of this product. Failure to turn power off may cause electrical shock or fire hazard.
- Special expertise is required to install, wire, configure, and operate this product. Person without such expertise must not use this product.
- This product uses an LCD (liquid crystal display) as a display device. The liquid inside the LCD is harmful to the skin. If the LCD is broken and the liquid attaches to your skin or clothing, wash the liquid off using soap, and consult a doctor immediately.
- An emergency circuit that uses emergency stop switch or an interlocking circuit must be configured outside of this product.
- Do not use touch switches for an emergency circuit or an interlocking circuit. If this product fails, serious injury to operators and equipment damage may be caused.
- If relays or transistors in this product output circuits should fail, outputs may remain at on or off state. For output signals which may cause serious accidents, configure monitor circuits outside this product.
- This product self-diagnostic function may detect internal circuit or program errors, stop programs, and turn outputs off. Configure circuits so that the system containing this product is not jeopardized when outputs turn off.
- In case this product is accidentally dropped or exposed to significant shock, stop using this product, check this product for damage, and confirm that its various functions work safely and correctly.
- Connect SmartAXIS's FG wire to grounding resistance of 100  $\Omega$  or less. Otherwise, there is a risk of electric shock or malfunction.
- The screen will not be visible if the backlight of this product burns out. However, the touch panel will remain functional. Thus, erroneous touch panel operation may occur while controlling the touch panel. Because such erroneous operations could result in damage, the touch panel should not be used once the backlight is burned out.

 **CAUTION**

- Prevent this product from falling while moving or transporting, otherwise it may cause damage or malfunction to this product as a result.
- Use the product within the environmental limits given in the catalog and this document. Use of the product in high-temperature or high-humidity environments, or in locations where it is exposed to condensation, corrosive gas, or large shock loads can create the risk of electrocution and fire.
- This product is designed for use in pollution degree 2. Use this product in environments of pollution degree 2. (based on the IEC 60664-1 rating)
- Install this product according to the this document. Improper installation will result in falling, failure, electrical shock, fire hazard, or malfunction of this product.
- Prevent metal fragments or wire chips from dropping inside this product housing. Ingress of such fragments and chips may cause fire hazard, damage, and malfunction.
- Use a power supply of the rated value. Using a wrong power supply may cause fire hazard.
- The main unit uses "PS2" as DC power supply. (based on the IEC/EN 61131 rating)
- Use wire of a proper size to meet the voltage and current requirements.
- When exporting this product to Europe, use an EN 60127 (IEC 60127) approved fuse on the power line outside this product.
- When exporting this product to Europe, use an EU-approved circuit protector.
- Make sure of safety before starting and stopping this product. Incorrect operation of this product may cause mechanical damage or accidents.
- This product cannot be directly connected to the communication lines (including public wireless LAN) of telecommunication carriers (mobile communication companies, fixed-line communication companies, Internet providers, etc.). When connecting this product to the Internet, be sure to connect via a device, such as a router.
- The touch panel of this product is made of glass, and will break if exposed to excessive shock. Take due care when handling it.
- When operating the touch panel in an environment where the ambient operating temperature exceeds 50°C, there is a risk of getting burn injury. So please use heat-resistant gloves, touch pen, and such to prevent burn injury.
- The protective film attached to the display of this product is to protect the product from scratches during transportation. Please remove the protective film before use. If the display is used with protective film, the film may become cloudy and stick to the display depending on the usage environment and may become unremovable.
- Do not push hard or scratch the touch panel and protection sheet with a hard object like hand tool. Touch panel and protection sheet can be easily damaged.
- Do not install this product in areas subjected to strong ultraviolet rays.
- Do not attempt to disassemble, repair or modify this product. This can create the risk of fire or electrocution.
- When disposing of this product, do so as an industrial waste.
- When using this product in a system that requires clock accuracy, set the time regularly.
- Do not switch off the power or pull out the USB flash drive while it is being accessed, as this may result in destruction of the stored data. If the data on the USB flash drive is corrupted, format the USB flash drive.
- Turn off the power supply of this product before connecting or disconnecting USB devices other than USB memory.

## Revision history

September 2023: First Edition

### Caution

- All rights in this document belong to IDEC Corporation. It may not be reproduced, reprinted, sold, transferred or rented without our permission.
- The contents of this document are subject to change without notice.
- Please contact your vendor or IDEC Corporation with any problems regarding the operation of this product.

### Trademarks

WindO/I and SmartAXIS are registered trademarks of IDEC CORPORATION in JAPAN.

All other company names and product names used in this document are trademarks of their respective owners.

### UL 121201 / CSA C22.2 No.213 (Under application)

- This product is for indoor use only.
- Open type or panel mounted when installed in a Listed Type 4X "Indoor Use Only", Type 13 enclosure.
- The use of an SELV source.
- When wiring this product at the field, use copper conductors only.

Test item particulars	
Type of item	Open Type/enclosed type when panel mounted in appropriate end enclosure
Description of equipment function	Control
Connection to mains supply	N/A connected to SELV source
Overvoltage Category	None
Pollution Degree	2
Environmental Conditions	Extended:
Temperature:	-20 to +55°C, see RATINGS section for detail.
Humidity:	10 to 90%RH (no condensation)
For use in wet locations	NO
Equipment mobility	Panel mounted
Operating Conditions	Continuous

- This product is suitable for use in Class I, Division 2, Groups A, B, C, D or Non-Hazardous locations only.
- RATINGS:  
Input: 24 Vde, 17W, SELV, LIM  
Maximum Surrounding Air: -20 to +55°C  
Enclosure Type 4X Indoor Use only, Type 13
- Temperature Code: T4A
- Equipment to be installed in an environmentally suitable enclosure that requires the use of a tool to access.
- L'appareil FT2J est conçu pour être utilisé uniquement dans des emplacements de classe I, division 2, groupes A, B, C, Dou non dangereux.
- Caractéristiques: Entrée: 24 Vde, 17W, Très basse tension de sécurité (SELV), LIMITES Air ambiant maximal: -20 à +55°C  
Boîtiers de type 4X pour une utilisation intérieure, de type 13.
- Code de température: T4A
- L'appareil FT2J doit être installé dans un boîtier adapté à l'environnement et uniquement accessible à l'aide d'outils.

## Preface

Thank you for purchasing the SmartAXIS manufactured by IDEC Corporation. This document describes the specifications of the SmartAXIS FT2J, how to install it, and various functions. Read this document to ensure the correct understanding of the entire functions of this product. IDEC Corporation makes the latest product manual PDFs available on our website at no additional cost. Please download the latest product manual PDFs from our website.

Read the following materials as necessary for your particular application.

References	Content
SmartAXIS FT2J Instruction Manual (This document)	Describes the product specifications, installation and wiring, or maintenance and inspection works for the FT2J.
WindO/I-NV4 User's Manual (PDF)	Describes the basic operations of the FT2J, how to create the project necessary for operation, and the various drawings and parts that make up the project.
Ladder Programming Manual (PDF)	Describes basic operations for programming with ladders, monitoring methods on the WindLDR, instruction lists, and details of each instruction.
SmartAXIS Hardware Manual (PDF)	Describes the product specifications, installation and wiring instructions of the FT2J, optional items, and I/O cartridges.
WindO/I-NV4 External Device Setup Manual (PDF)	Describes the connection procedures and available device addresses for various communication including the Device Link Communication, O/I Link communication, and DM Link communication.

## Symbols Used in this document

This document uses the following symbols to facilitate explanation.

### Symbols



..... Information that requires special attention. Failure to operate the product in accordance with the information provided can lead to serious injury or damage.



..... Information relating to requests or material to reference in the use of a function



..... Useful information relating to a function

**OK**

..... Screen buttons are indicated by bold text or by using the actual graphic icon.

**\*\*\*\***

..... Controls are indicated by bold text.

**Abbreviations, Generic Terms, and Terminology Used in this document**

<b>Item</b>	<b>Description</b>
FT2J	The name is short for SmartAXIS FT2J-7U22*AF-* .
SmartAXIS	Generic term for integrated display controller FT2J.
External Device	Generic term used to refer to a PLC or micro computer that is connected to and communicates with the main unit.
Device Address	Memory that is capable of storing values in unit of bits or words loaded on the main unit and external device.
WindO/I-NV4	Integrated configuration software application for creating projects of the main unit.
Operating System	Software used to manage and control system software.
System Software	Software that performs basic control and management of the main unit.
Project	Data including image data required for operating the main unit, which is created with WindO/I-NV4.
Internal Device	The generic term for internal device addressing on the main unit such as internal relays, registers, etc.

## Contents

SAFETY PRECAUTIONS .....	Preface-1
Revision history .....	Preface-3
Caution .....	Preface-3
Trademarks.....	Preface-3
UL 121201 / CSA C22.2 No.213 (Under application) .....	Preface-3
Preface .....	Preface-4
Symbols Used in this document .....	Preface-5
Abbreviations, Generic Terms, and Terminology Used in this document .....	Preface-6

## Chapter 1 Main Unit Specifications





1	FT2J .....	1-1
	1.1 Packing Content.....	1-1
	1.2 Type Number.....	1-1
	1.3 Part Names.....	1-2
	1.4 External Interfaces.....	1-3
	1.5 Specifications.....	1-11
	1.6 Dimensions.....	1-14
	1.7 Installation .....	1-15
	1.8 Wiring .....	1-20
	1.9 Maintenance and Inspection .....	1-24
	1.10 Software License Information.....	1-25

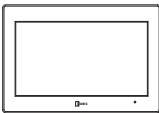
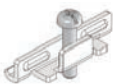
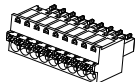

## 1 FT2J

### 1.1 Packing Content

Before installing the main unit, make sure that the model you have received is what you actually ordered, and no parts are damaged to accidents during shipping.

Product Name & Dimensions	Quantity	Description
FT2J 	1	Main unit
Mounting clips 	4	-
Serial interface connector 	1	Removable terminal block 9-pin
Input terminal connector 	1	Removable terminal block 16-pin
Output terminal connector 	1	Removable terminal block 11-pin
Dummy cartridge 	2	Attached to the main unit

### 1.2 Type Number

LCD	Bezel Color	Input Terminal Specification	Output Terminal Specification	Type Number
7.0 inch wide TFT Color	Black	Digital input (shared sink/source): 10 Analog input (shared digital sink input): 4	Relay output: 8	FT2J-7U22RAF-B
			Transistor sink output: 6 Analog output: 2	FT2J-7U22KAF-B
			Transistor source output: 6 Analog output: 2	FT2J-7U22SAF-B

### 1.3 Part Names

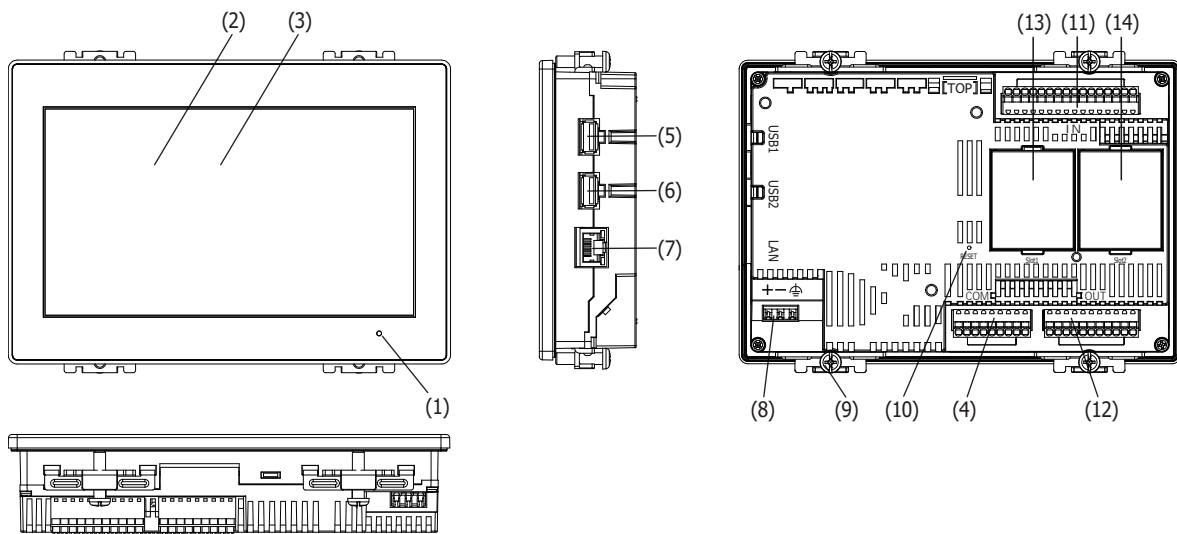

No.	Name	Description
(1)	POWER LED	Green (lit): Normal Operation Green (flash): Operating system is booting. (Normal Operation) Orange (lit): Operating system is booting. (Boot mode) Orange (flash): Preparing to boot the operating system, running in boot mode. Red (lit): Main unit is damaged. Not lit : Power is off.
(2)	Display	TFT color LCD
(3)	Touch Panel	PCAP touchscreen (Projected capacitive)
(4)	Serial Interface (COM)	RS232C, RS422/485 Connector: Terminal Block 9-pin (Push-in type) Maximum cable length: 15m (RS232C), 1200m (RS422/485)
(5)	USB Interface (USB1)	USB2.0 (Host) Connector: Type A Output current: 5V 500 mA
(6)	USB Interface (USB2)	USB2.0 (Host) Connector: Type A Output current: 5V 500 mA
(7)	Ethernet Interface (LAN)	IEEE802.3u 10BASE-T/100BASE-TX Connector: RJ-45 (With Auto MDI/MDI-X function) Maximum cable length: 100m
(8)	Power Supply Terminal	Connector: Terminal Block 3-pin (Push-in type)
(9)	Mounting Clip Position	4 places
(10)	RESET Switch	-
(11)	Input terminal (IN)	Connector: Removable terminal block 16-pin (Push-in type) Digital input (shared sink/source) (I0 to I7, I10, I11) Analog input (shared digital sink input) (I12 to I15)
(11)	Output terminal (OUT)	Connector: Removable terminal block 11-pin (Push-in type) Relay Output (Q0 to Q7) Transistor sink output (Q0 to Q5), Analog output (AQ0, AQ1) Transistor source output (Q0 to Q5), Analog output (AQ0, AQ1)
(13)	Cartridge Slot (Slot1)	Slots for connecting the following I/O cartridges. For details about the cartridges, refer to Chapter 2 "I/O Cartridge" in the Smart AXIS Hardware Manual.
(14)	Cartridge Slot (Slot2)	Digital I/O cartridge: FC6A-PN4, FC6A-PTK4, FC6A-PTS4 Analog I/O cartridge: FC6A-PJ2A, FC6A-PJ2CP, FC6A-PK2AV, FC6A-PK2AW

## 1.4 External Interfaces

### CAUTION

- Make sure to turn off the power to the FT2J before wiring each interface.
- The serial interface (COM) can be used as the RS232C and RS422/485 interfaces at same time.
- Use the SELV (Safety Extra-Low Voltage) circuit to connect the Serial, USB and Ethernet interfaces.
- Use the SELV (Safety Extra-Low Voltage) circuit and LIM (Limited Energy) when connecting a DC power supply to the Input and Output terminals.
- When using the relay output load that exceeds AC200V, please connect COM2 and COM3 to the same voltage circuit.

#### ● Serial Interface (COM)

Use applicable cables for wiring and recommended ferrules (made by IDEC, Weidmüller or Phoenix Contact) as follows.

Interface Specification	RS232C, RS422/485		
Connector	Removable terminal block 9-pin		
Applicable cable	AWG16 to 28		
Conductor Type	Solid wire or Stranded wire		
Wire Strip Length*1	8 to 9 mm		
Recommended ferrule	ST3L-H025-12WJ S3TL-H034-12WT S3TL-H05-14WA S3TL-H075-14WW (IDEC)	H0,25/12 HBL H0,34/12 TK H0,5/14 OR H0,75/14 W (Weidmüller)	AI 0,25-8YE AI 0,34-8TQ AI 0,5-8WH AI 0,75-8GY (Phoenix Contact)

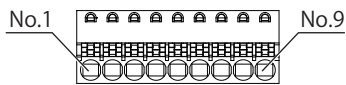

No.	Name	I/O	Function	Communication type	
1	SD	OUT	Send Data	RS232C	/
2	RD	IN	Receive Data		
3	RS	OUT	Request to Send		
4	CS	IN	Clear to Send		
5	SG	—	Signal Ground	RS422/485	/
6	SDA	OUT	Send Data (+)		
7	SDB	OUT	Send Data (-)		
8	RDA	IN	Receive Data (+)		
9	RDB	IN	Receive Data (-)		

\*1 Strip the sheath of the wire 8 to 9 mm from the end.

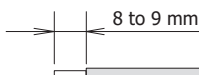

### Using RS422/485 interface

FT2J is not equipped with terminating resistor. Insert a terminating resistor of an appropriate value (about 100 to 120 Ohm, 1/2 W minimum) between terminal number 8 (RDA) and terminal number 9 (RDB), if necessary.

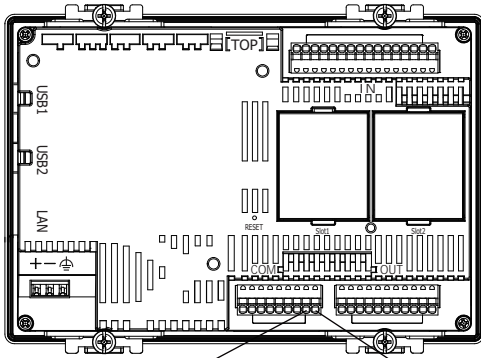

Terminal Number 8 (RDA) Terminal Number 9 (RDB)

For inserting and removing wires, refer to "1.8 Wiring" on page 1-20

### ● Input Terminal (IN)

Use applicable cables for wiring and recommended ferrules (made by IDEC, Weidmüller or Phoenix Contact) as follows.

Connector	Removable terminal block 16-pin (Push-in type)		
Applicable cable	AWG 16 to 28		
Conductor Type	Solid wire or Stranded wire		
Wire Strip Length *1	8 to 9 mm		
Recommended ferrule	ST3L-H025-12WJ S3TL-H034-12WT S3TL-H05-14WA S3TL-H075-14WW (IDEC)	H0,25/12 HBL H0,34/12 TK H0,5/14 OR H0,75/14 W (Weidmüller)	AI 0,25-8YE AI 0,34-8TQ AI 0,5-8WH AI 0,75-8GY (Phoenix Contact)
Input Points	14		
Rated Input Voltage	24V DC		
Input Voltage Range	0 to 28.8V DC		
Effect of Improper Input Connection	No damage However, if high voltage is applied that exceeds the operating input voltage range, there is a risk of permanent damage.		

\*1 Strip the sheath of the wire 8 to 9 mm from the end.

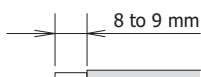

Digital Input

Input Type		Shared sink/source	
Input Points (Terminal Number/Common Line Name)		10 points in 1 common line (I0 to I7, I10, I11 / COM0 terminal)	
Rated Input Current	I0 to I5	4 mA/point (at 24V DC)	
	I6, I7, I10, I11	5 mA/point (at 24V DC)	
Input Impedance	I0 to I5	6.3 kΩ	
	I6, I7, I10, I11	4.5 kΩ	
Input Delay Time	Turn ON Time	I0 to I5	25 μs maximum + software filter setting
		I6, I7, I10, I11	100 μs maximum + software filter setting
	Turn OFF Time	I0 to I5	25 μs maximum + software filter setting
		I6, I7, I10, I11	100 μs maximum + software filter setting
Isolation	Between Input Terminal and Internal Circuit	Photocoupler isolated	
	Between Input Terminals	Not isolated	
Input Type		Type1 (IEC 61131-2)	
External Load for I/O Interconnection		Not isolated	
Signal Determination Method		Static	
Effect of Improper Input Connection		Even if wiring for sink or source connection is incorrect, no damages are caused. However, if high voltage is applied that exceeds the operating input voltage range, there is a risk of permanent damage.	
Cable Length in compliance with electromagnetic immunity		3 m	

■ Operating Ranges

**I0 to I5**

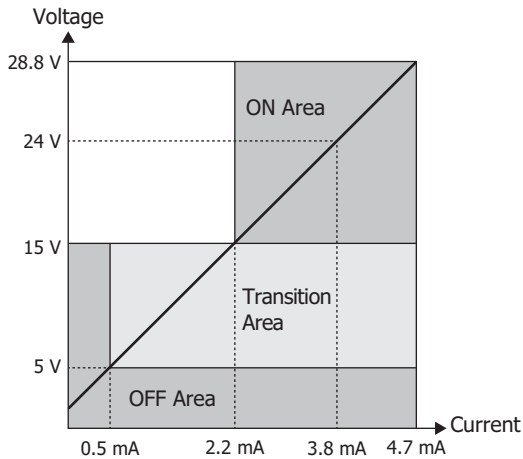

**I6, I7, I10, I11**

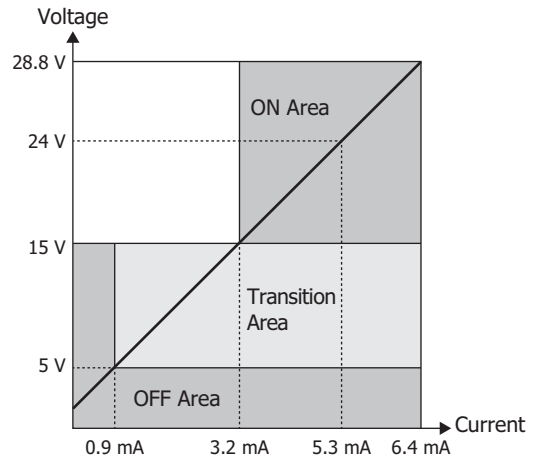

■ Input Equivalent Circuit

**I0 to I5**

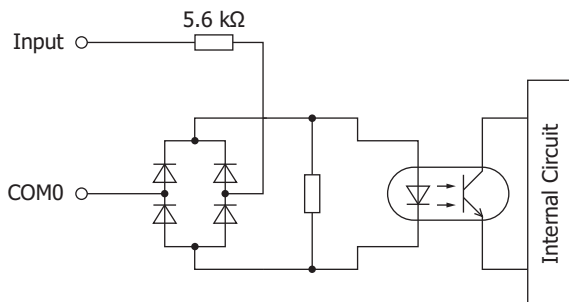

**I6, I7, I10, I11**

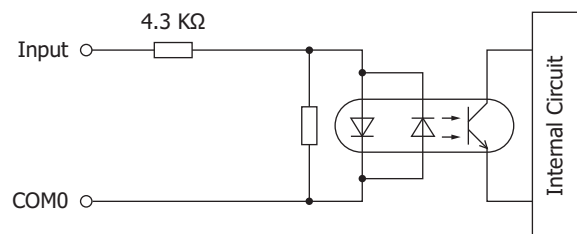

Analog Input (shared digital sink input)

Input Type*1		Voltage	Current
Input Points (Terminal Number/Common Line Name)		4 points in 1 common line (I12 to I15/ COM1(-) terminal)	
Input Range		0 to 10V DC	4 to 20 mA
Input Impedance		78kΩ	250kΩ
Digital Resolution		4096 (12 bit)	
Data Type		Can be set for each channel. Binary data: 0 to 4095 Optional range*2: -32768 to 32767	
AD Conversion	Sampling time	5 msec max.	
	Sample Repetition Time	5 msec max.	
	Total Input Delay Time	6 msec + 1 scan time	
	Type of Input	Single-ended	
	Operation Mode	Self-scan	
	Conversion Method	SAR	
Input Error	Maximum Error at 25°C	±3.0% of full scale	
	Temperature Coefficient	±0.04% of full scale/°C	
	Maximum Error	±5.0% of full scale	
Status Display		Device Monitor screen (LCD display)	
Noise Resistance	Maximum Temporary Deviation during Electrical Noise Tests	±5.0% of full scale	
	Input Filter	Yes	
	Recommended Cable for Noise Immunity	Shielded cable	
Calibration to Maintain Rated Accuracy		Not possible	
Maximum Permanent Allowed Overload (No Damage)		28.8V DC	
Overload Status (Outside Input Range) Detection		Detectable	
Isolation	Between Input Terminal and Internal Circuit	Not isolated	
	Between Input Terminals	Not isolated	
Used as Digital Input	Digital Input Type	— (IEC 61131-2 digital input type is not supported)	
	Input Threshold	ON voltage: 15V min.	ON current: 0.20 mA min.
		OFF voltage: 5V max.	OFF current: 0.06 mA max.

Pulse Input

The maximum input frequency varies based on the input terminal and function.

Input Terminal			I0	I1	I2	I3	I4	I5
Function	High-speed counter	Adding counter	20 kHz	-	20 kHz	20 kHz	20 kHz	20 kHz
		Up/down selection reversible counter	20 kHz	-	-	-	-	-
		Dual-pulse reversible counter	20 kHz	20 kHz	-	-	-	-
		2-edge count	10 kHz	10 kHz	-	-	-	-
		4-edge count	5 kHz	5 kHz	-	-	-	-
	Catch input		20 kHz	-	20 kHz	20 kHz	20 kHz	20 kHz
	Interrupt input		20 kHz	-	20 kHz	20 kHz	20 kHz	20 kHz
	Frequency measurement		-	-	20 kHz	20 kHz	20 kHz	-

\*1 Can be set by application software.

\*2 This function is used the analog value converting it to the specified range.

## ■ Operating Ranges

### I12 to I15

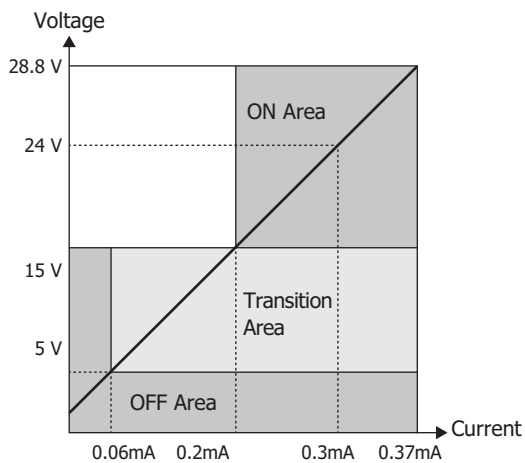

## ■ Input Equivalent Circuit

### I12 to I15

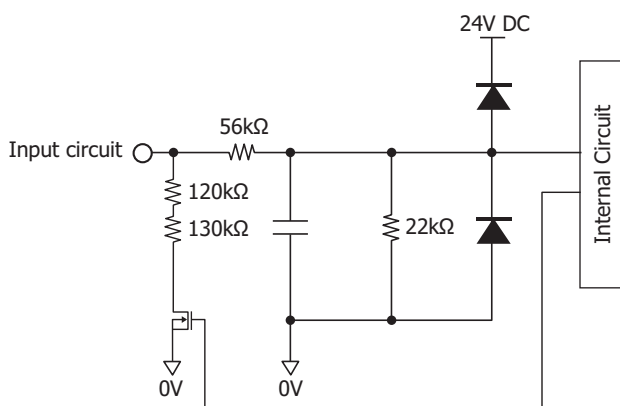

## ● Output Terminal (OUT)

Use applicable cables for wiring and recommended ferrules (made by IDEC, Weidmüller or Phoenix Contact) as follows.

Connector	Removable terminal block 11-pin (Push-in type)		
Applicable cable	AWG16 to 28		
Conductor Type	Solid wire or Stranded wire		
Wire Strip Length*1	8 to 9 mm		
Recommended ferrule	ST3L-H025-12WJ S3TL-H034-12WT S3TL-H05-14WA S3TL-H075-14WW (IDEC)	H0,25/12 HBL H0,34/12 TK H0,5/14 OR H0,75/14 W (Weidmüller)	AI 0,25-8YE AI 0,34-8TQ AI 0,5-8WH AI 0,75-8GY (Phoenix Contact)

### Relay Output

Type Number	FT2J-7U22RAF-B	
Output Points (Terminal Number)	8 (Q0 to Q7)	
Output Type	1a contact	
Maximum Load Current	1	2 A max.
	1 common line	7 A max.
Minimum Switching Load	1 mA, 5V DC (reference value)	
Initial Contact Resistance	30 mΩ max.	
Electrical Life	100,000 operations min. (rated resistive load 1,800 operations/hour)	
Mechanical Life	20,000,000 operations min. (no load 18,000 operations/hour)	
Rated Load	240V AC 2 A, 30V DC 2 A	
Withstand Voltage	Between Output Terminal and Internal Circuit	2,300V AC 5 mA, 1 minute
	Between Output Terminals (COM2 and COM3)	
Status Display	Device Monitor screen (LCD display)	

### Output Delay

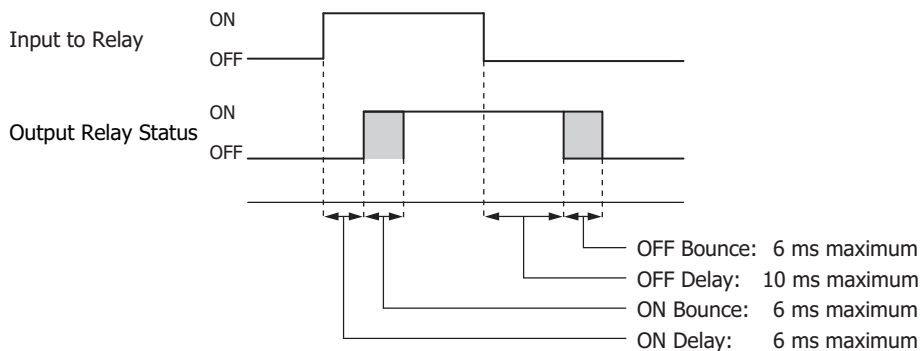

\*1 Strip the sheath of the wire 8 to 9 mm from the end.

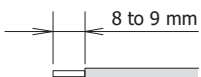



Transistor Output

Type Number	FT2J-7U22KAF-B	FT2J-7U22SAF-B
Output Points	6 (Q0 to Q5)	
Output Type	Sink output	Source output
Rated Load Voltage	24V DC	
Operating Input Voltage Range	20.4 to 28.8 DC	
Maximum Load Current	1	0.5 A
	1 common line	3 A
Voltage Drop (ON Voltage)	1V max. (Voltage between COM and output terminal when ON)	
Maximum Inrush Current	1 A max.	
Leakage Current	0.1 mA max.	
Inductive Load	L/R=10 ms (28.8V DC, 1 Hz)	
	100 mA max., 24V DC	
External Current Draw	V(+) terminal supply power	COM2(+) terminal supply power
Isolation	Photocoupler isolated	
Status Display	Device Monitor screen (LCD display)	

## ■ Output Equivalent Circuit

## FT2J-7U22KAF-B

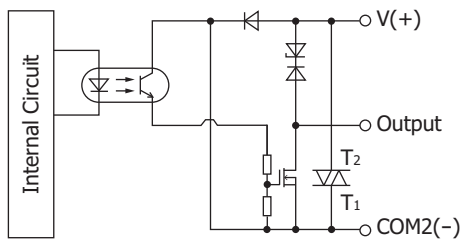

## FT2J-7U22SAF-B

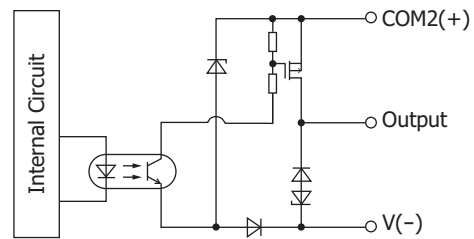

## Analog Output

Type Number		FT2J-7U22KAF-B, FT2J-7U22SAF-B	
Output Type*1		Voltage	Current
Output Points (Terminal Number/Common Line Name)		2 / 1 common line (AQ0, AQ1 / COM3(-) terminal)	
Output Range		0 to 10V DC	4 to 20 mA DC
Output Load	Impedance	2 k $\Omega$ or higher	500 $\Omega$ or lower
	Load Type	Resistive load	
DA Conversion	Scan Time	1 scan	
	Settling time	1 ms or lower	
	Total Output System Transfer Time	1 ms + 1 scan time	
Output Error	Maximum Error at 25°C	$\pm 0.3\%$ of full scale	
	Temperature Coefficient	$\pm 0.02\%$ of full scale	
	Reproducibility after Stabilization Time	$\pm 0.4\%$ of full scale	
	Non-linearity	$\pm 0.01\%$ of full scale	
	Output Ripple	30 mV maximum	
	Overshoot	0%*2	
	Maximum Error	$\pm 1.0\%$ of full scale	
Data	Digital Resolution	4,096 (12 bits)	
	Data Type	Can be set for each channel. Binary data: 0 to 4095 Optional range*3: -32768 to 32767	
	Monotonicity	Yes	
	Current Loop Open	Not detectable	
Noise Resistance	Maximum Temporary Deviation during Electrical Noise Tests	$\pm 5.0\%$ or less of full scale	
	Recommended Cable for Noise Immunity	Shielded cable	
Effect of Improper Output Connection		No damage	
Calibration to Maintain Rated Accuracy		Not possible	

### ■ Output Equivalent Circuit

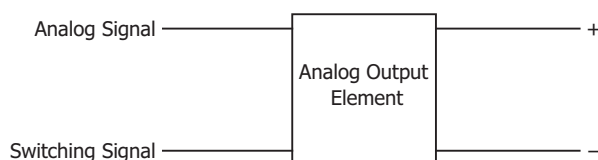

## Pulse Output

Type Number	FT2J-7U22KAF-B	FT2J-7U22SAF-B
Output Points	4 (Q0 to Q3)	
Maximum output pulse frequency	20kHz	
PWM output	Duty cycle: 0.1 to 100.0 (increments of 0.1%) Output pulse frequency: 30 to 1000 (increments of 1Hz) When the pulse OFF time is shorter than 25 $\mu$ s, the pulse ON ratio is adjusted so that the OFF time is 25 $\mu$ s and output the signal. When the pulse ON time is shorter than 25 $\mu$ s, the pulse OFF ratio is adjusted so that the ON time is 25 $\mu$ s and output the signal.	

\*1 Can be set by application software.

\*2 Overshoot may occur at light loads. The occurrence of overshoot can be controlled by inserting damping resistance into the circuit. A general guide for the damping resistance value is about 150  $\Omega$  including the input line impedance for the destination.

\*3 This function is used the analog value converting it to the specified range.

## 1.5 Specifications

### ■ Applicable Standards

Safety Standards	UL61010-1, UL61010-2-201, CSA C22.2 No.61010-2-201 (c-UL), UL121201, CSA C22.2 No.61010-1-12 (c-UL), CSA C22.2 No.213 (c-UL)
EMC Standards	IEC/EN 61131-2

### ■ Environmental Specifications

Ambient Operating Temperature	-20 to +55°C*1 (no freezing)
Ambient Operating Humidity	10 to 95% RH (no condensation)
Ambient Storage Temperature	-20 to +70°C (no freezing)
Ambient Storage Humidity	10 to 95% RH (no condensation)
Altitude	Up to 2000m
Pollution Degree	2
Corrosion Immunity	Free from corrosive gases

### ■ Electrical Specifications

Rated Voltage	24V DC				
Power Consumption	17W maximum				
<table border="1" style="width: 100%;"> <tr> <td>Not using the USB1 and USB2 interfaces, the IN and OUT terminals, and the Slot1 and Slot2 slots.</td> <td>5W maximum</td> </tr> <tr> <td>When Backlight OFF</td> <td>3W maximum</td> </tr> </table>	Not using the USB1 and USB2 interfaces, the IN and OUT terminals, and the Slot1 and Slot2 slots.	5W maximum	When Backlight OFF	3W maximum	
Not using the USB1 and USB2 interfaces, the IN and OUT terminals, and the Slot1 and Slot2 slots.	5W maximum				
When Backlight OFF	3W maximum				
Power Voltage Range	20.4 to 28.8V DC				
Allowable Momentary Power Interruption	10 ms maximum (Power supply voltage: 24.0V DC to 28.8V DC) 5 ms maximum (Power supply voltage: 20.4V DC to 24.0V DC)				
Inrush Current	40 A maximum				
Dielectric Withstand Voltage	500V AC, 5 mA, 1 minute (between power and earth terminals) 500 V AC, 5 mA, 1 minute (between input and earth terminals) 2300 V AC, 5 mA, 1 minute (between relay output and earth terminals) 500 V AC, 5 mA, 1 minute (between transistor output and earth terminals) 500 V AC, 5 mA, 1 minute (between power and input terminals) 500 V AC, 5 mA, 1 minute (between power and transistor output terminals) 2300 V AC, 5 mA, 1 minute (between power and relay output terminals) 500 V AC, 5 mA, 1 minute (between input and transistor output terminals) 2300 V AC, 5 mA, 1 minute (between input and relay output terminals)				

### ■ Construction Specifications

Type Number	FT2J-7U22RAF-B	FT2J-7U22KAF-B, FT2J-7U22SAF-B
Vibration Resistance	5 to 8.4Hz amplitude 3.5mm, 8.4 to 150Hz acceleration 9.8m/s <sup>2</sup> 10 times on each of three mutually perpendicular axes (IEC 61131-2)	
Shock Resistance	98m/s <sup>2</sup> , 11ms (3 shocks on each of three mutually perpendicular axes) (IEC 61131-2)	147m/s <sup>2</sup> , 11ms (3 shocks on each of three mutually perpendicular axes) (IEC 61131-2)

\*1 For details about the restrictions due to the ambient operating temperature, refer to "Restrictions due to mounting orientation" on page 1-17.

## ■ Function Specifications

Display	LCD Type <sup>*2</sup>	TFT color LCD
	Display Colors	65,536 Colors
	Effective Display Area	154.08 (W) × 85.92 (H) mm
	Display Resolution	800 (W) × 480 (H) dots
	Dot pitch	0.1926 (W) × 0.179 (H) mm
	View angle	Left/Right/Top: 80°, Bottom: 60°
	Brightness of LCD only	500 cd/m <sup>2</sup>
	Brightness Adjustment	48 levels
	Backlight	LED (white)
	Backlight Life <sup>*3</sup>	Approx. 50,000 hours (The time until brightness becomes 50% of the initial value)
Touch Panel	Switch Type	Projected Capacitive
	Multiple Operations	Possible (2-point touch)
User Memory		Approx. 24 MB
Backup time of the real-time clock (Ambient Operating Temperature at 25°C)		Min. 20 days <sup>*5</sup>
Backup Data	Keep by a large-capacity capacitor	Clock Data
	Save to non-volatile memory	Log data, HMI Keep Relays, HMI Keep Registers, Internal Relays, Shift Registers, Counters, Data Registers
Buzzer output		Single tone (tone length is adjustable)
Degree of Protection <sup>*4</sup>		Panel thickness is 1mm or more and less than 1.6mm: IP65F (IEC 60529) Panel thickness is 1.6mm or more and 5mm or less: IP66F, IP67F (IEC 60529), TYPE 4X (indoor use only), TYPE 13
Weight (approx.)		600g

\*2 Please be aware that small black and bright dots might show up on LCD Screen: it is not a failure or malfunction.

\*3 The life of the LCD itself at an ambient operating temperature of 25°C. This is not a guaranteed value. The actual life depends on the environment and conditions of use.

\*4 It is a protection structure for the operating surface of HMI, which is attached to a panel. Although protection structure suffices every test conditions, it does not guarantee to operate under all of the environmental condition. As for IP65F/IP66F/IP67F oilproof structure, it suffices oilproof test conditions. Conditions are listed in the document that comes with Japanese Industrial Standard JIS C 0920.

Protection structure do not gurantee usage under long exposure to oil or usage of oil that is not prescribed in the document. Please test/check beforehand to avoid trouble.

IP ratings are not applicable to UL certification.

\*5 If the power interruption period exceeds the Backup time of the real-time clock, the error message "Initialize clock data" will be displayed when the power is turned on, and the clock data will be initialized to 00:00:00 on January 1, 2000.

## ■ EMC Specifications

Radiated Emission	Class A: 10m 40dB $\mu$ V/m quasi-peak (30M to 230MHz) 47dB $\mu$ V/m quasi-peak (230M to 1GHz) Class A: 3m 76dB $\mu$ V/m (Peak), 56dB $\mu$ V/m (AVG) (1G to 3GHz) 80dB $\mu$ V/m (Peak), 60dB $\mu$ V/m (AVG) (3G to 6GHz)
Electrostatic Discharge	Contact: $\pm$ 6kV Air: $\pm$ 8kV
Electromagnetic Field	10V/m (80M to 1000MHz) 3V/m (1.4G to 2.0GHz) 3V/m (2.0G to 2.7GHz) 3V/m (2.7G to 6.0GHz) 80% AM (1kHz)
Fast Transient Burst	Power: $\pm$ 2kV Communication cable: $\pm$ 1kV
Surge Immunity	$\pm$ 500V (between +24V and 0V) $\pm$ 500V (between +24V and FE, 0 and FE)
Conducted Radio Frequency Immunity	10V (Power, Communication cable) (150k to 80MHz) 80% AM (1kHz)

## 1.6 Dimensions

Unit: mm

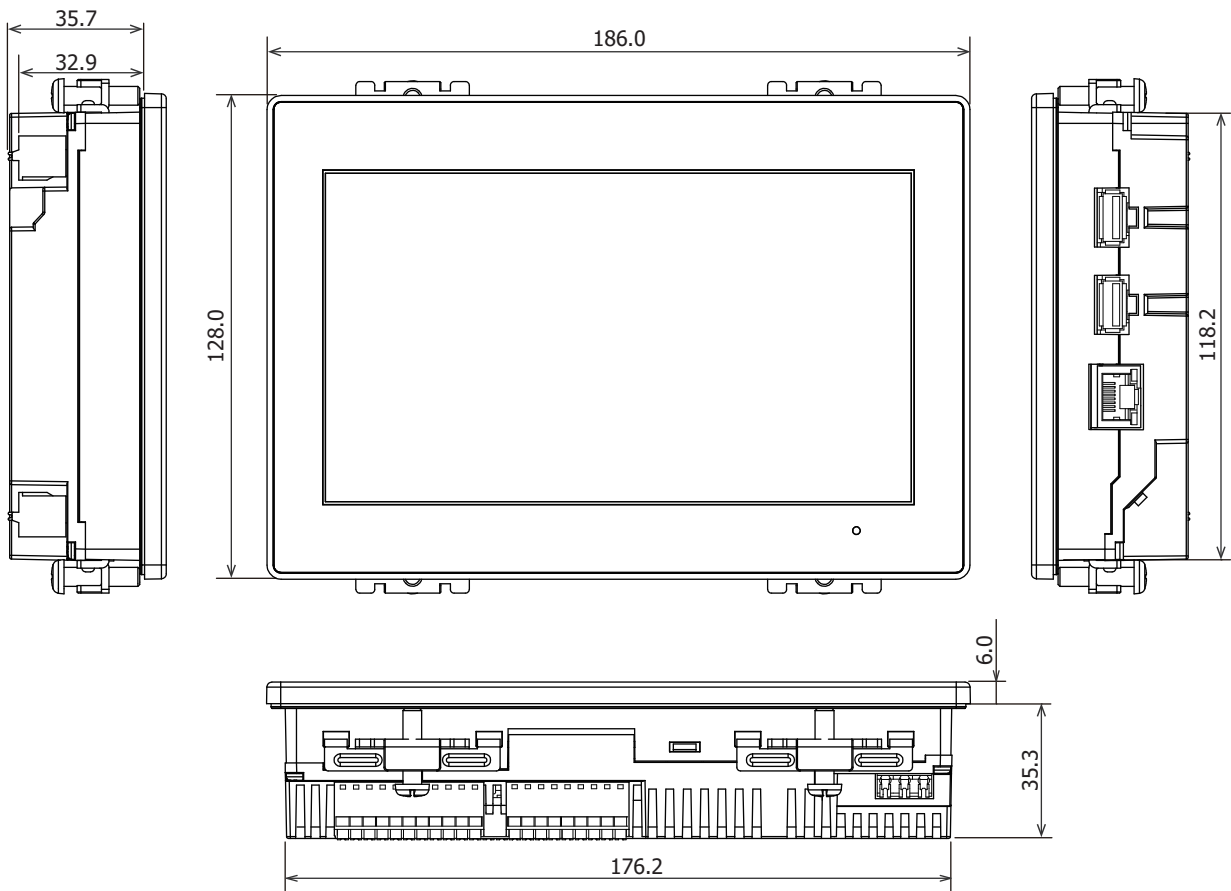

### <Cable Attached Dimensions>

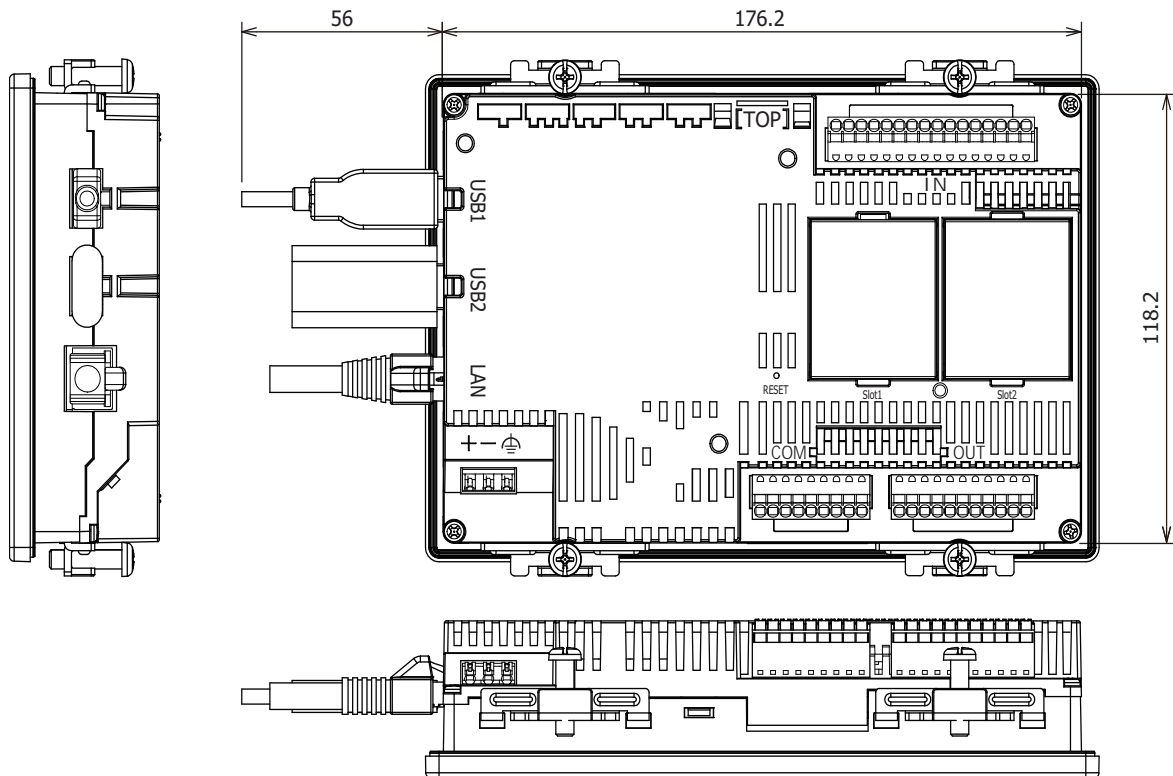

Depending on the type of connection cable used the dimensions shown above will change. The dimensions given here are representative values and are intended for reference only.

## ● About the printed contents of the main unit

"Mark A" indicates that you can refer to the instruction sheet by using the QR code. For details about Conductor material and wire size, refer to "1.4 External Interfaces" on page 1-3 and "1.8 Wiring" on page 1-20.

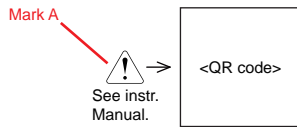

## 1.7 Installation

### ● Operating Environment

For designed performance and safety of the FT2J, do not install the FT2J in the following environments:

- Where dust, briny air, or iron powder exist.
- Where oil or chemical splashes for a long time.
- Where space is filled with oil mist.
- Where direct sunlight falls on the FT2J.
- Where strong ultraviolet rays fall on the FT2J.
- Where corrosive or combustible gasses exist.
- Where shocks or vibrations are transmitted.
- Where condensation occurs due to rapid temperature change.
- Where high-voltage or arc-generating equipment (electromagnetic contactors or circuit protectors) exists in close proximity.

### ● Ambient Temperature

- Allow sufficient space for ventilation, and install the equipment away from heat sources.
- Allow at least 100mm between the FT2J and walls or other equipment.
- Do not install the FT2J where the ambient temperature exceeds the rated ambient operating temperature range. When mounting the FT2J in such locations, provide a forced air-cooling fan or air-conditioner to keep the ambient temperature within the rated temperature range.
- The FT2J is designed to install on a vertical plane so that natural air-cooling is provided. If you install it using any other orientation, use forced-air cooling, or lower the ambient operating temperature.

### ● About Derating

FT2J suppresses the temperature rise inside the product by reducing the backlight brightness when the ambient operating temperature becomes high.

Relationship between the ambient operating temperature and brightness is as follows.

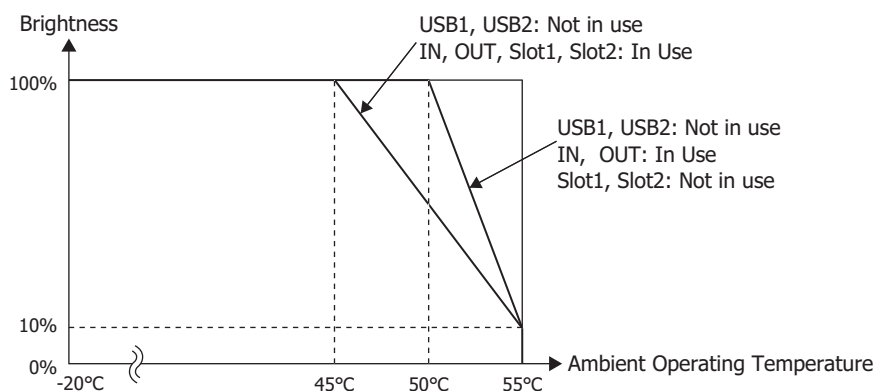

Brightness reduction occurs depending on the usage of the USB interface, IN, OUT, and cartridge slots.

Depending on each product the values shown above will change. The values given here are representative values are intended for reference only.

## ● Installation

- Make a panel cut-out on the panel with the dimensions shown below.

Unit: mm

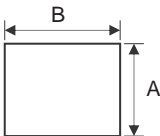

A	B	Panel Thickness
118.6 $\begin{smallmatrix} +1.0 \\ 0 \end{smallmatrix}$	176.6 $\begin{smallmatrix} +1.0 \\ 0 \end{smallmatrix}$	1.0 to 5.0

- Use the attached mounting clips to tighten the screws evenly to mount panel: screws must be applied on total of four places with the specified torque 0.5 to 0.6N·m.

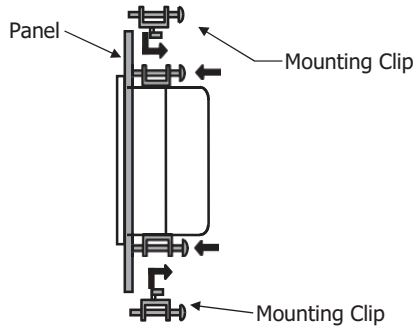

## CAUTION



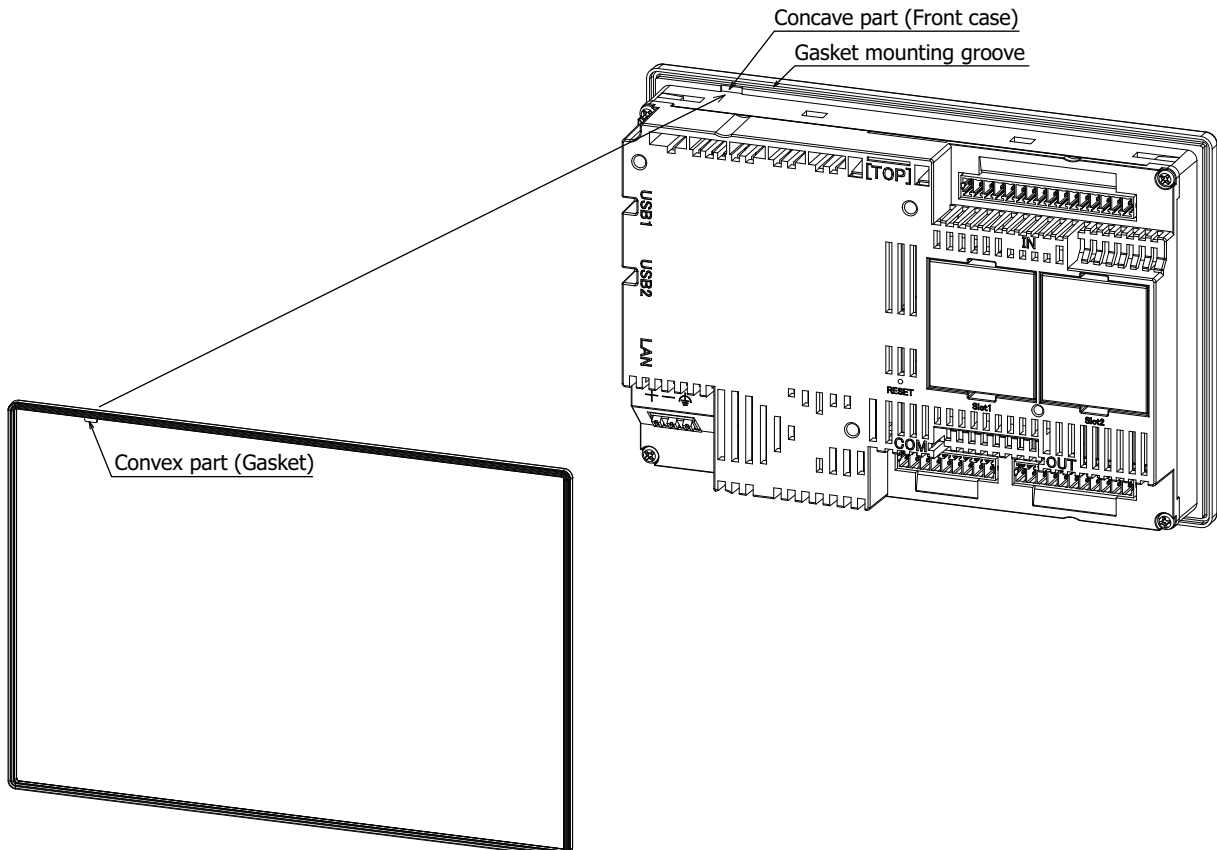

- Mount the FT2J on a rigid panel.
- Do not tighten with excessive force, otherwise the FT2J may warp the display, or impair the waterproof characteristics.
- If the mounting clips are tightened obliquely to the panel, the FT2J may fall off the panel.
- When installing the FT2J into a panel cut-out, make sure that the gasket is not twisted. Especially when re-installing, take special care because any twists in the gasket will impair the waterproof characteristics. Also, if the gasket comes off the main unit, align the convex part of the gasket with the concave part of the front case, and then insert the gasket fully into the gasket mounting groove without twisting it.



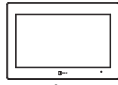

### ● Restrictions due to mounting orientation

The FT2J is designed to install on a vertical landscape. The ambient operating temperature and the output current of the USB interface (total of USB1 and USB2) are limited as shown in the table below.

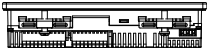
Orientation		Ambient Operating Temperature: Output current limitation of USB interface
Vertical	 Landscape	-20 to +45°C: 1000 mA +45 to +50°C: 500 mA +50 to +55°C: 150 mA
	 Portrait (Clockwise)	-20 to +40°C: 1000 mA +40 to +55°C: 150 mA
	 Portrait (Counter Clockwise)	-20 to +40°C: 1000 mA +40 to +55°C: 150 mA
	 Landscape (Rotate 180°)	-20 to +50°C: 500 mA +50 to +55°C: 150 mA
 Horizontal		-20 to +50°C: 500 mA +50 to +55°C: 150 mA



- When installing the FT2J in a diagonal, the limitations are same as a horizontal.
- Confirm the visibility of the display in a final installation.
- When mounting in Landscape (Rotate 180 degrees) or Horizontal orientation, it is not possible to use the USB interface with an output current that exceeds 500mA.
- Cartridge slots (Slot1, Slot2) cannot be used in the following cases.
  - Orientation is in Vertical - Portrait (Clockwise) or - Portrait (Counter Clockwise) and the ambient operating temperature is +50 to +55°C.
  - Orientation is in Horizontal and the ambient operating temperature is +45 to +55°C.
- FC6A-PK2AW cannot be used when the orientation is in Horizontal and the ambient operating temperature is +40 to +45°C.

For details about how to install the cartridge, refer to Chapter 2 "1.6 Install and remove" or Chapter 2 "2.6 Install and remove" in the Smart AXIS Hardware Manual.

By reducing the input voltage and input utilization (simultaneous ON ratio: a%) of I0 to I7, I10 and I11, use within the ambient operating temperature range appropriate for the mounting orientation.

Type No.	FT2J-7U22RAF-B	FT2J-7U22KAF-B, FT2J-7U22SAF-B
Landscape		
Portrait (Clockwise)		
Portrait (Counter Clockwise)		
Landscape (Rotate 180°)		
Horizontal		

If in compliance with UL standards, please follow the diagram below to reduce the input voltage and input usage rate (ON state ratio: a%) accordingly.

Type No.	FT2J-7U22RAF-B	FT2J-7U22KAF-B, FT2J-7U22SAF-B
Landscape		
Portrait (Clockwise)		
Portrait (Counter Clockwise)		
Landscape (Rotate 180°)		
Horizontal		

## 1.8 Wiring

### ⚠ CAUTION

- Turn off the power supply before wiring.
- Make the wiring as short as possible and run all wires as far away as possible from high-voltage and large-current cables. Follow all the procedures and precautions when wiring the FT2J.
- Separate the FT2J power supply wiring from the power lines of I/O devices and motor equipment.
- Ground the functional earth terminal to make sure of correct operation.
- Use the SELV (Safety Extra-Low Voltage) circuit and LIM (Limited Energy) circuit for power supply.
- Use Copper Conductors Only.

### ● Terminal Arrangement and Wiring Examples

#### FT2J-7U22RAF-B

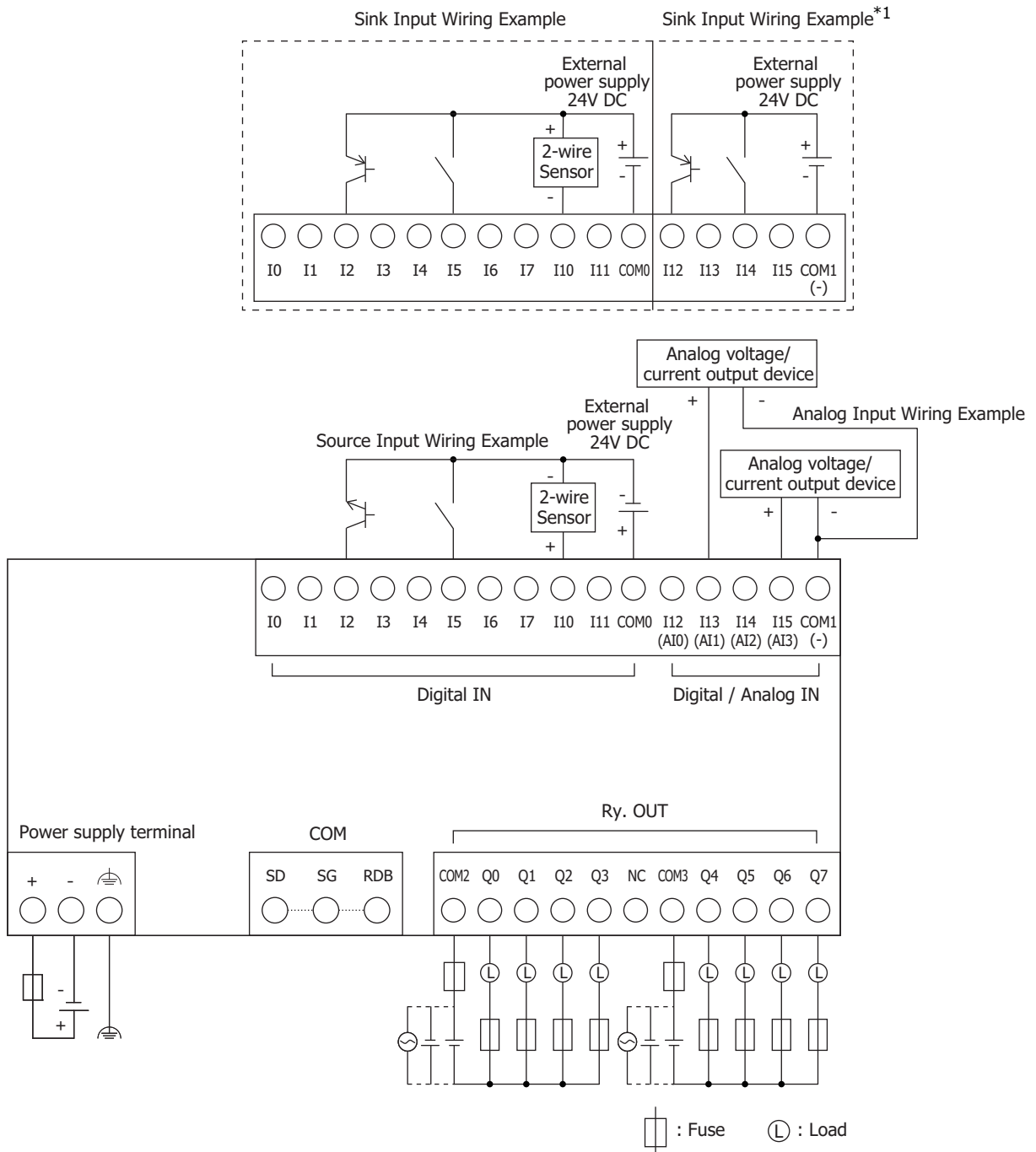

\*1 I12 to I15 cannot be used as source inputs.

FT2J-7U22KAF-B

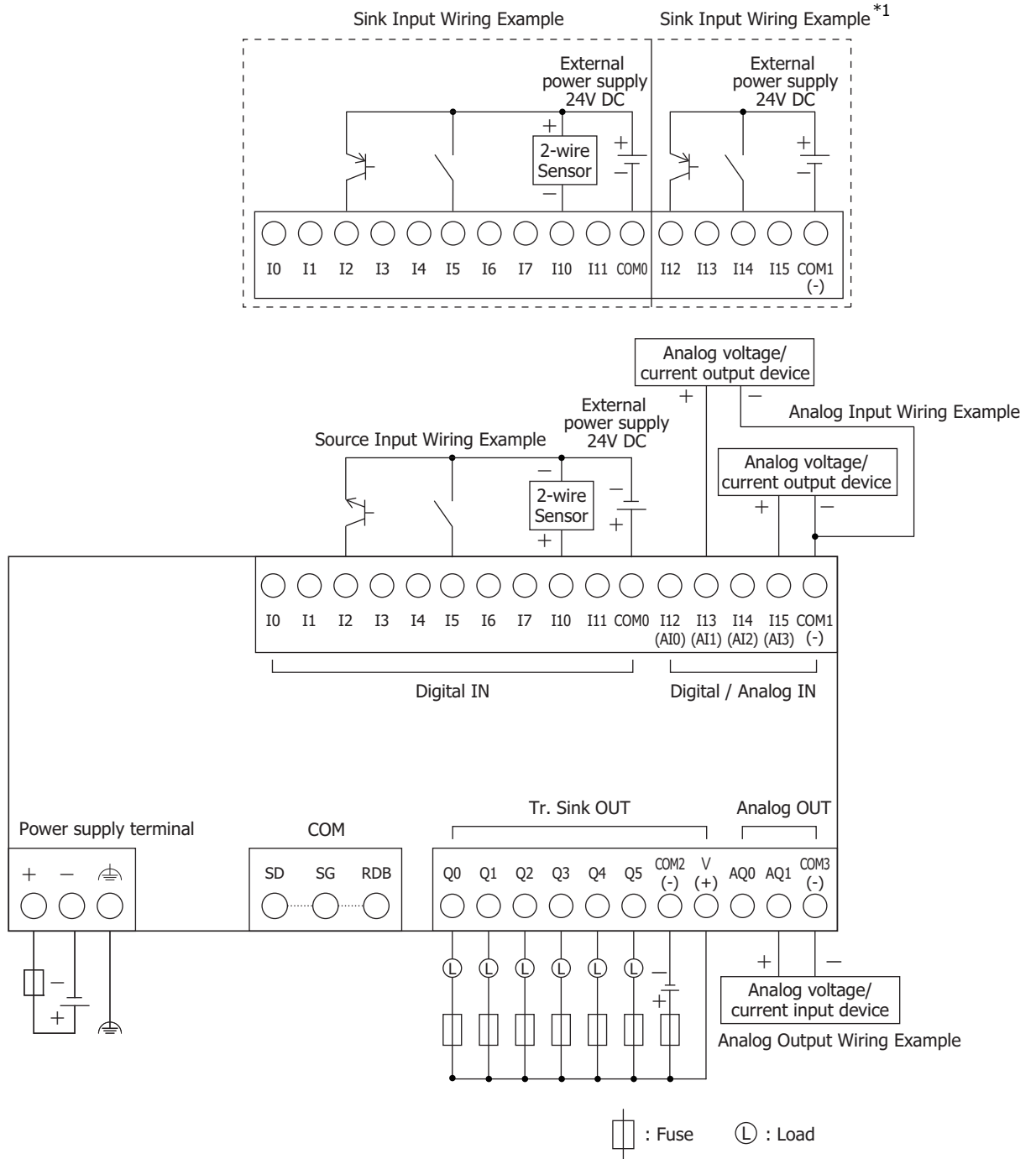

\*1 I12 to I15 cannot be used as source inputs.

**FT2J-7U22SAF-B**

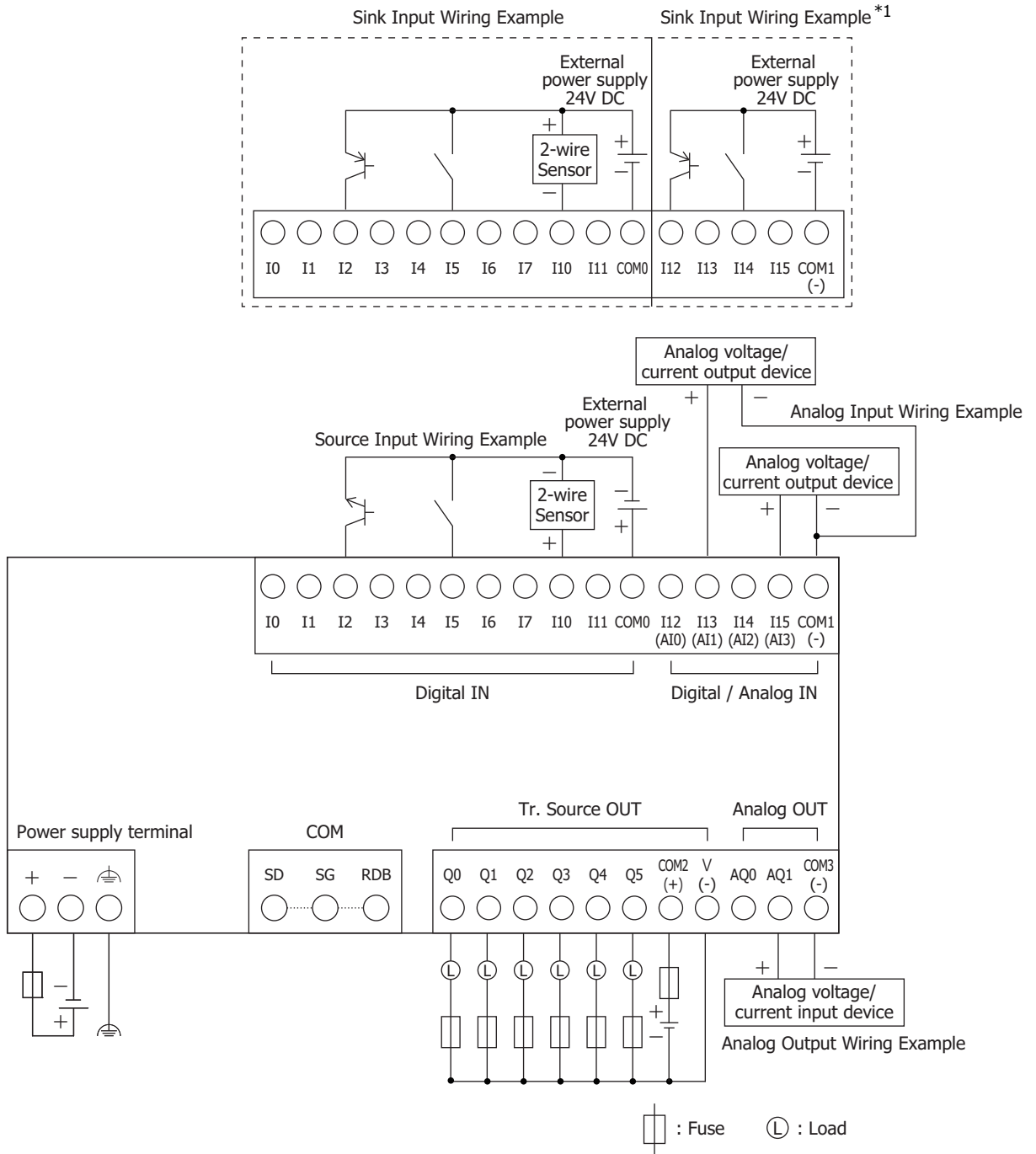

\*1 I12 to I15 cannot be used as source inputs.

## ● Power Supply Terminal

- Pin assignment is shown in the following table.

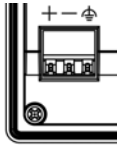

+	Power supply (24V DC)
-	Power supply (0V)
	Functional Earth (FE)

- Use applicable cables for wiring and recommended ferrules (made by IDEC, Weidmüller or Phoenix Contact) as follows.

Applicable cable	AWG14 to 28		
Conductor Type	Solid wire or Stranded wire		
Wire Strip Length*1	7 to 9 mm		
Recommended ferrule	ST3L-H025-12WJ S3TL-H034-12WT S3TL-H05-14WA S3TL-H075-14WW (IDEC)	H0,25/12 HBL H0,34/12 TK H0,5/14 OR H0,75/14 W (Weidmüller)	AI 0,25-8YE AI 0,34-8TQ AI 0,5-8WH AI 0,75-8GY (Phoenix Contact)

## ● Caution when inserting and removing wires

- When connecting a wire that has not been treated with a tip, such as a stranded wire, you can connect it by inserting the wire all the way in while pressing the pusher, and then releasing the pusher.
- When connecting wires with ferrules, connect the ferrules to the terminal block so that the long side is horizontal. (See the figure below.)

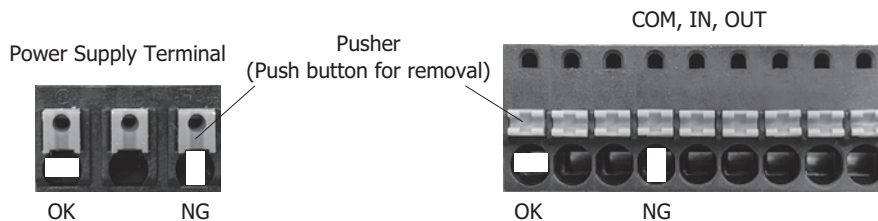

- Do not pull out the wire without pressing the pusher. When pulling out the wire, use a flat blade screwdriver, etc., and pull the wire straight out while pressing the pusher with about 20 N of force.
- Be careful not to damage the push-in terminals. When pressing the pusher, do not apply more than 40N of force.

## ● Cautions for using the FT2J connected to a personal computer

When connecting the FT2J to a personal computer via the USB Interfaces, the FT2J or the personal computer may break down depending on the conditions of the personal computer. Make sure of the following cautions, in order to prevent an accident.

- If the personal computer has a 3-pin power plug or power plug with a ground lead type, make sure to use a plug socket including a ground input electrode or ground the earth lead, respectively.
- If the personal computer has a 2-pin power plug without ground lead, follow the procedure below when connect the FT2J to the personal computer.
  - (1) Pull out the power plug of the personal computer from the AC outlet.
  - (2) Connect the FT2J to the personal computer.
  - (3) Insert the power plug of the personal computer into the AC outlet.

\*1 Strip the sheath of the wire 7 to 9 mm from the end.

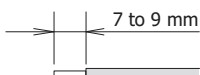

● Recommended Tools

Tool Name		Model Number (Order Number)	Manufacturer
Flat blade screwdriver	Normal type	SDS 0.4×2.5×75 (9009030000)	Weidmüller
	With insulated cover	S3TL-D04-25-75	IDEC
		SDIS 0.4×2.5×75 (9008370000)	Weidmüller
Crimping tool		S3TL-CR06D	IDEC
		PZ6/5 (90011460000)	Weidmüller
Stripping tool		S3TL-ST06	IDEC
		STRIPAX(9005000000)	Weidmüller

## 1.9 Maintenance and Inspection

Maintain and inspect the FT2J periodically to ensure the best performance. Do not disassemble, repair, or modify the FT2J during inspection.

Maintenance and Inspection Parts	Description
Display	Wipe any stain of the display using a soft cloth slightly dampened with neutral detergent or alcoholic solvent. Do not use solvents such as thinner, ammonia, strong acid, and strong alkaline.
Terminals, Connectors	Check the terminals and connectors to make sure of no loose screws, incomplete insertion, or disconnected lines.
Mounting Clips	Make sure that all mounting clips and screws are tightened sufficiently. If the mounting clips are loose, tighten the screw to the specified torque.
Backlight	The FT2J's backlight cannot be replaced by the customer. When the backlight needs to be replaced. Contact your vendor or IDEC Corporation.

● Maintenance Screen

Turn on the power to the FT2J, then press and hold the touch panel on the upper-left corner of the screen for three seconds or longer. The Maintenance Screen appears on the screen.

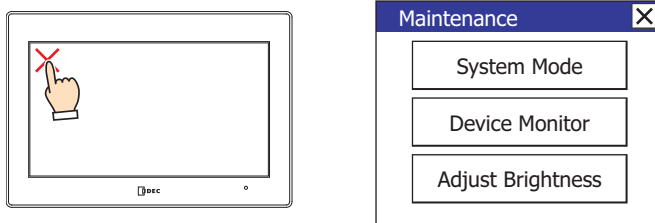

Maintenance Screen

- Permission to show the Maintenance Screen can be set using the WindO/I-NV4. For details, refer to Chapter 4 "3.1 System Tab" in the WindO/I-NV4 User's Manual.
- The Maintenance Screen is not displayed in the System Mode.

● System Mode

Press the [System Mode] at the top of the Maintenance Screen. The Top Page Screen appears.

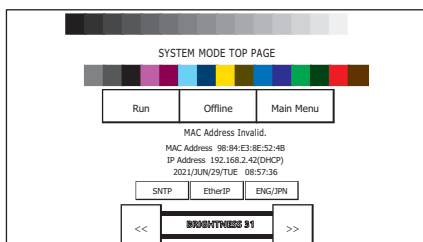

Initial Setting, Self Diagnosis and Initialization of the data, etc can be executed in the System Mode.



## ● Adjusting the Brightness

The brightness of the FT2J display can be adjusted on the Adjust Brightness Screen.

- 1 Press the [Adjust Brightness] at the bottom of the Maintenance Screen. The Adjust Brightness Screen appears.

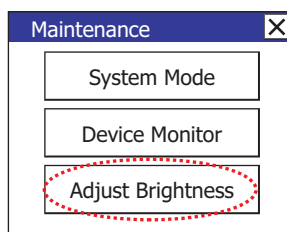

- 2 Press the [<<] and [>>] at the bottom the Adjust Brightness Screen to adjust the contrast to the optimal setting.



- 3 Press the [X] to close the Adjust Brightness Screen.



To adjust the brightness in the System Mode, use the [<<] and [>>] buttons located at the bottom of the Top Page.

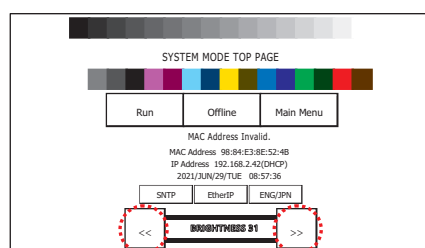

## 1.10 Software License Information

This product contains various open source software in addition to the software owned by IDEC Corporation. Information about open source software can be obtained from the QR code printed on the back of the FT2J.

# About the Warranty of the products

## 1 Warranty Period

The warranty period for IDEC products shall be three (3) year after purchase or delivery to the specified location. However, this shall not apply in cases where there is a different specification in the Catalogs or there is another agreement in place between you and IDEC.

## 2 Warranty scope

Should a failure occur in an IDEC product during the above warranty period for reasons attributable to IDEC, then IDEC shall replace or repair that product, free of charge, at the purchase location/delivery location of the product, or an IDEC service base. However, failures caused by the following reasons shall be deemed outside the scope of this warranty.

- i. The product was handled or used deviating from the conditions/environment listed in the Catalogs
  - ii. The failure was caused by reasons other than an IDEC product
  - iii. Modification or repair was performed by a party other than IDEC
  - iv. The failure was caused by a software program of a party other than IDEC
  - v. The product was used outside of its original purpose
  - vi. Replacement of maintenance parts, installation of accessories, or the like was not performed properly in accordance with the user's manual and Catalogs
  - vii. The failure could not have been predicted with the scientific and technical standards at the time when the product was shipped from IDEC
  - viii. The failure was due to other causes not attributable to IDEC (including cases of force majeure such as natural disasters and other disasters)
- \* Customers assume their own risk in programming products, Company will not be held liable for damages as a result of improper programming.

Furthermore, the warranty described here refers to a warranty on the IDEC product as a unit, and damages induced by the failure of an IDEC product are excluded from this warranty.

## 3 Service scope

The prices of IDEC products do not include the cost of services, such as dispatching technicians. Therefore, separate fees are required in the following cases.

- (1) Instructions for installation/adjustment and accompaniment at test operation (including creating application software and testing operation, etc.)
- (2) Maintenance inspections, adjustments, and repairs
- (3) Technical instructions and technical training
- (4) Product tests or inspections specified by you

# IDEC CORPORATION

Head Office 6-64, Nishi-Miyahara-2-Chome, Yodogawa-ku, Osaka 532-0004, Japan

 [www.idec.com](http://www.idec.com)

**USA** IDEC Corporation  
**EMEA** APEM SAS

**Singapore** IDEC Izumi Asia Pte. Ltd.  
**Thailand** IDEC Asia (Thailand) Co., Ltd.  
**India** IDEC Controls India Private Ltd.

**China** IDEC (Shanghai) Corporation  
IDEC Izumi (H.K.) Co., Ltd.  
**Taiwan** IDEC Taiwan Corporation

**Japan** IDEC Corporation

EU Authorized Representative: APEM SAS  
55, Avenue Edouard Herriot BP1, 82303 Caussade Cedex, France

UK Authorized Representative: APEM COMPONENTS LIMITED  
Drakes Drive, Long Crendon, Buckinghamshire, HP18 9BA, UK

Specifications and other descriptions in this document are subject to change without notice.  
Information in this document is current as of September, 2023.  
2023 IDEC Corporation, All Rights Reserved.

B-2345(0)

